

WRCS III

Wide Range Current Sensor



User Manual

Version 1.6 – 14.11.2023

Content

1	Block diagram	3
2	User Interface	4
2.1	Display	5
2.2	Rotary encoder	5
2.3	BNC Output <i>Common</i>	5
2.4	BNC Output A, B, C	5
2.5	Load current connection	5
3	Menu navigation	6
3.1	Main menu	6
3.2	Menu "Filter"	7
3.3	Menu "Output"	8
3.4	Menu "Out Com"	8
3.5	Menu "Out A", "Out B", "Out C"	9
3.6	Menu Protection	9
3.7	Menu Fuse	10
3.8	Menu Screen Saver	10
3.9	Menu Version	11
4	Function of "Common"-Output	12
5	Overcurrent protection	13
6	Reverse polarity protection	13
7	Technical specification	14



1 Block diagram

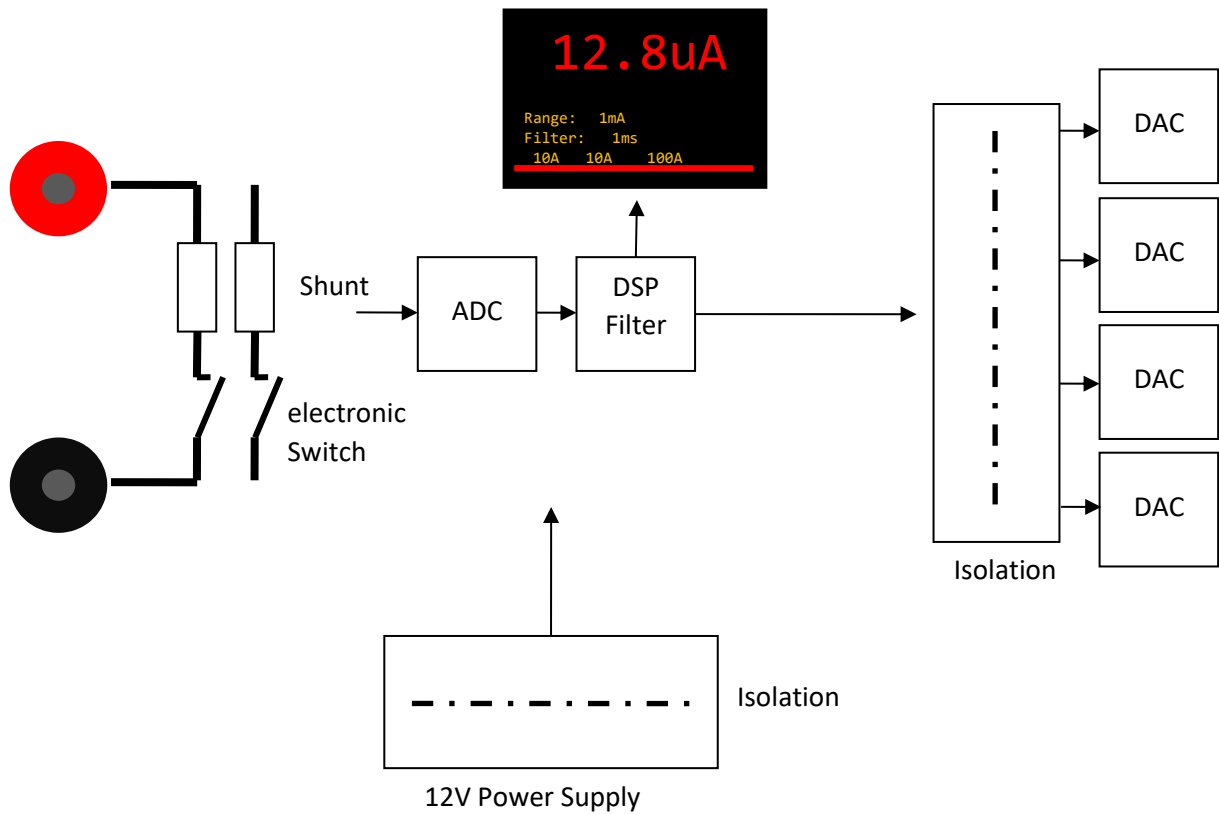

2 User Interface

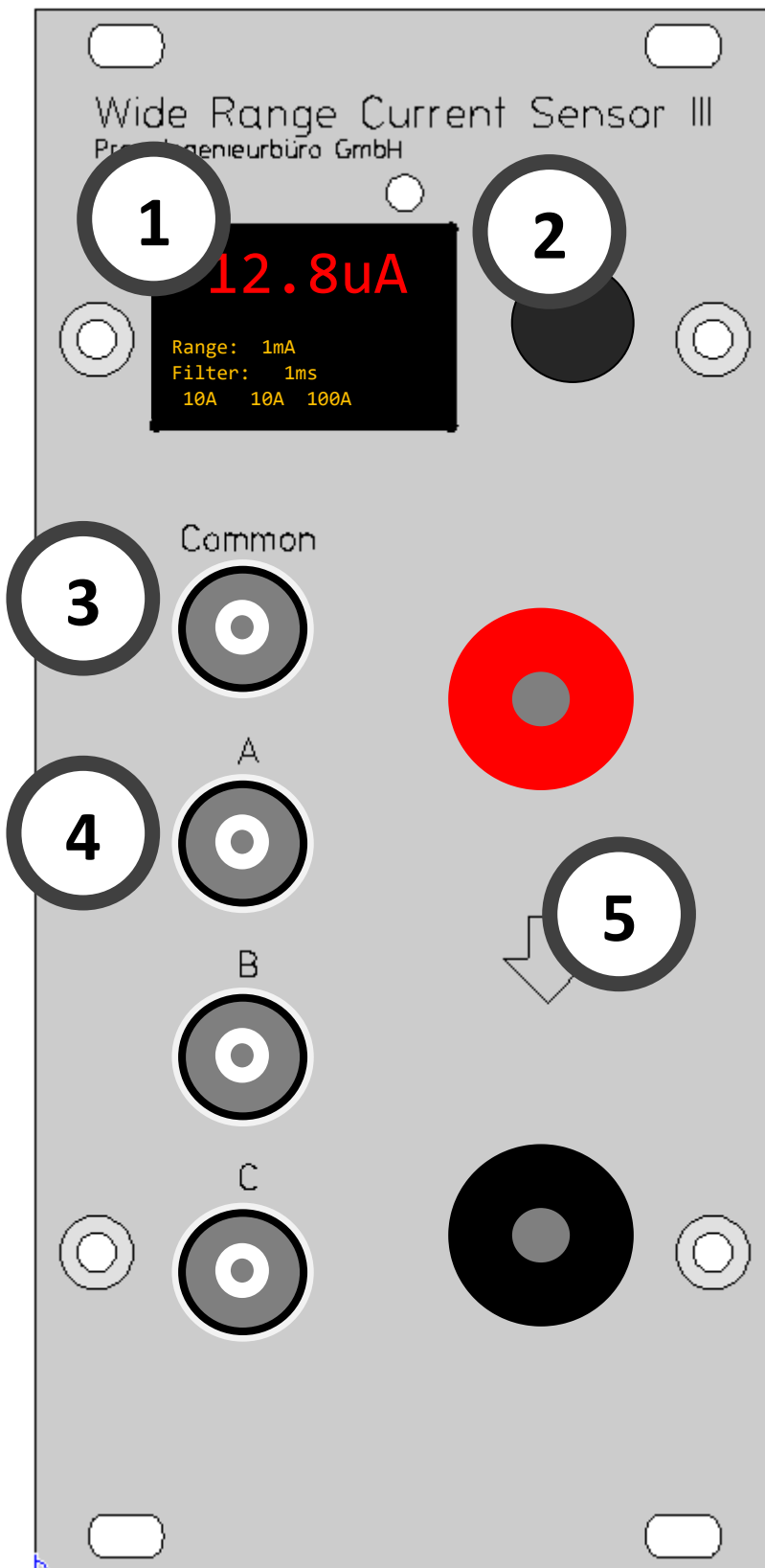

2.1 Display

The OLED display shows the actual current and settings.

2.2 Rotary encoder

Select the menu by pressing the knob.

Change settings by rotating the knob.

2.3 BNC Output *Common*

Current value from 0 .. 200A results in an output voltage of 0 .. 6.2V. Each decade from 1mA to 100A is 1V on the output. For detailed curves see chapter Function of “Common”.

2.4 BNC Output A, B, C

Current value output as voltage from 0..1V or 0..10V. Configurable by Menu setting “Output”.

The voltage range of the analog digital converters is always 0 .. 10V. By using the 1V range, only 10% of the analog range is used resulting in higher quantization noise. For better accuracy and better signal to noise ratio use the 10V range. The 1V range only is implemented for compatibility to current systems.

2.5 Load current connection

The load current has to flow through the pole terminals in direction of the arrow (from top/red to bottom/black).

For continuous load currents >70A a minimum wire size of 35mm² is mandatory to avoid additional heat input from the hot wires into the device.

The connection between the pole terminals is in a high impedance state, if the WRCS III is switched off. The internal switch has a dielectric withstanding voltage of 55V.

3 Menu navigation

3.1 Main menu

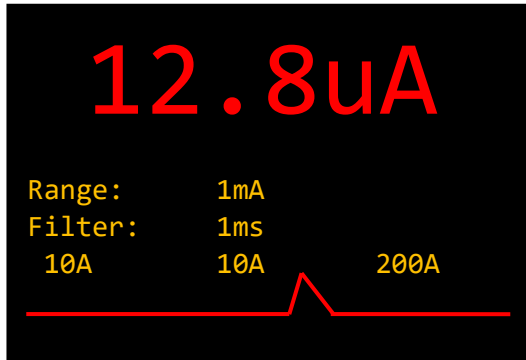

12.8uA Actual measured current

Range: 1mA Actual measurement range

Filter: 1ms Filter time constant of a digital PT1 filter. Adjustable in menu "Filter".

10A 10A 200A Measurement range of the 3 outputs A, B, C. Configurable in the menus "Out A", "Out B", "Out B".



Temporal course of the current. The graph shows the relative current in the current measurement range. If the range changes to the next range, the color of the graph toggles between red and orange.

3.2 Menu “Filter”



Filter time constant of the digital PT1 (IIR)-Filter.

It is recommended to select a filter time, which is higher than the sample interval of the connected multimeter/data logger to avoid aliasing.

Additionally, a wrong setting may result in an offset error because of the nonlinear characteristic curve of the COM output.

Possible settings:

No Filt – ADC-data is put out unfiltered

100 μ s

1ms

10ms

100ms

1s

10s

Filter time constant	3dB cutoff frequency
No Filt	\approx 6kHz analog bandwidth
100 μ s	1,59 kHz
1ms	159 Hz
10ms	15,9Hz
100ms	1,59Hz
1s	0,159Hz
10s	0,0159 Hz

3.3 Menu "Output"

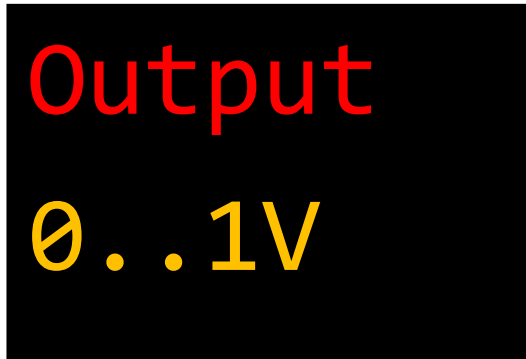

Current value at the outputs A, B, C. Set to 0..1V or 0..10V.

The voltage range of the analog digital converters is always 0 .. 10V. By using the 1V range, only 10% of the analog range is used resulting in higher quantization noise. For better accuracy and better signal to noise ratio use the 10V range. The 1V range only is implemented for compatibility to current systems.

Possible settings:

0..1V

0..10V

3.4 Menu "Out Com"



Activates/deactivates the common output. For a very fast output of the current value, the output sample frequency can be increased to 50kHz by using only one output channel.

Possible settings:

-off-

-on-

3.5 Menu “Out A”, “Out B”, “Out C”

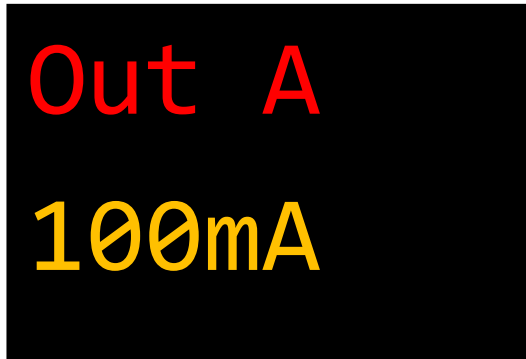

Setting of the measurement range for the outputs A,B or C. Additionally the output can be disabled to increase the output sample frequency to 50kHz.

Possible settings:

-off-
1mA
10mA
100mA
1A
10A
100A
200A

3.6 Menu Protection



Possible settings:

-off-	No self protection
Rev-Pol	Reverse polarity protection
Overcur	Overcurrent protection
-Both-	Reverse polarity protection + overcurrent protection

You lose warranty if you disable the protection features.

3.7 Menu Fuse

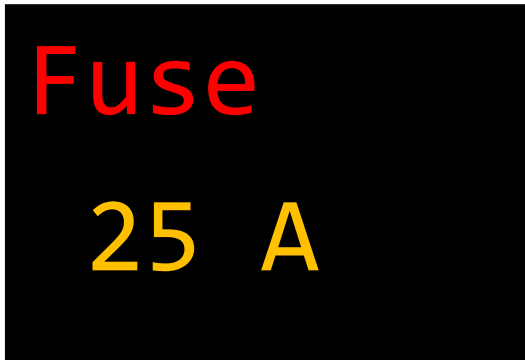

When the set threshold is exceeded, the internal electronic circuit breaker interrupts the circuit. The filter time set in the Filter menu is used as the trip time constant.

ATTENTION:

If voltages of more than 60V occur when the fuse triggers, this can lead to a defect of the device. This must also be taken into account when measuring purely inductive loads.

3.8 Menu Screen Saver

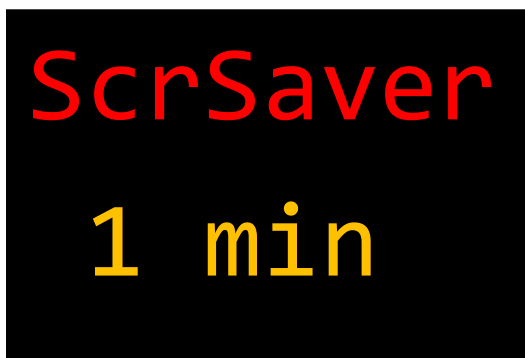

Possible settings:

1 min
10 min
1 hour
10 hours
disabled

The display of the device is an OLED. This display technology tends to burn in the bright pixels during long periods of operation. In order to reduce the aging of the display, especially during long continuous operation over weeks, the screensaver should be activated. It dims the display to lower brightness values after a short time.

The device has a presence detection function. If there is movement in front of the device, the screensaver is deactivated and the display shows the measured value with full brightness. This detection can also be triggered by people passing by, so that in continuous operation, short set times achieve the greatest gain in display life.



3.9 Menu Version



Display of the software version und the maximum continuous current of the device.



4 Function of “Common”-Output

The Outputs A, B and C are mapping a preselected measurement range to an output voltage from 0..10V (0..1V).

In contrast the “Common” output is able to map the complete measurement range of the device from 0 μ A to 200A to the output. Every current decade is represented by a voltage rise of 1V.

Current range	Output voltage	Example current	Example voltage
0... 999.9 μ A	0... 999.9mV	250 μ A	0.250V
1.000mA ... 9.999mA	1.1000V .. 1.9999V	2.5mA	1.250V
10.00mA ... 99.99mA	2.1000V .. 2.9999V	25mA	2.250V
100.0mA ... 999.9mA	3.1000V .. 3.9999V	250mA	3.250V
1.000A ... 9.999A	4.1000V .. 4.9999V	2.5A	4.250V
10.00A ... 99.99A	5.1000V .. 5.9999V	25A	5.250V
100.0A ... 200.0A	6.1000V .. 6.2000V	125A	6.125V

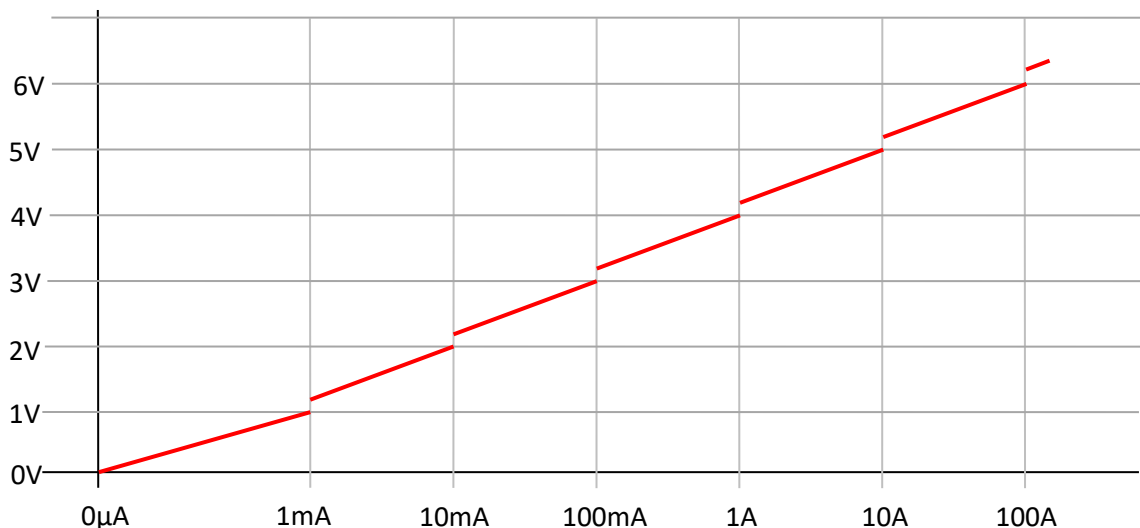

You may interpret the output voltage also as exponential notation of the current.

The number before the decimal point from 0 to 6 represents the measurement range from 1mA to 200A. The decimal represents the current value of the measurement range.

Example:

3.250V

↑
3 = range 1A
↑
.250 = 0.250 of 1A = 250mA

5 Overcurrent protection

If the overcurrent protection is active, a thermo model protects the device against excessive current draw and cuts the internal connection by an internal 60V MosFet switch. The permitted continuous current depends on the hardware configuration and the housing. If the protection is deactivated, a warning is displayed, if the trip current is exceeded.

Single device without internal fan	: 70A
Single device with internal fan	: 80A
Rack version without internal fan in rack with forced ventilation	: 80A
Rack version with internal fan in rack with forced ventilation	: 90A
Rack version with internal fan in rack with forced ventilation (since 10/2019)	: 120A

The grayed variants are no longer in production.

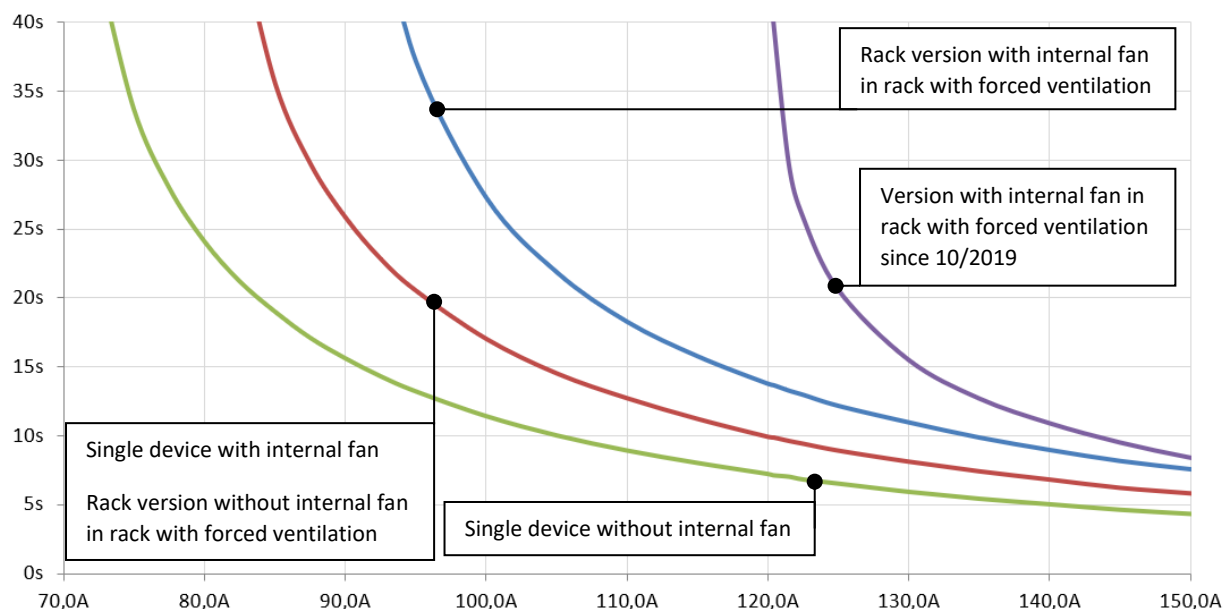

At an overcurrent event, the device cuts off the current und protects itself.
To reactivate, press the rotary encoder.

6 Reverse polarity protection

The reverse polarity protection prevents negative current.

If the reverse polarity protection is activated, the device cuts off the load circuit after a short time of negative current draw. To reactivate, press the rotary knob.

If the reverse polarity protection is deactivated, continuous negative currents are possible.

The device internally selects the appropriate measurement range to protect the internal shunt resistors against excessive power dissipation. The selection of the appropriate range by the autorange logic after return to positive currents may take a while.



7 Technical specification

Power supply:	12V +-1V								
Current consumption:	90mA ... 180mA								
Max. continuous current:	<table> <tr> <td>Single device without internal fan</td> <td>: 70A</td> </tr> <tr> <td>Single device with internal fan</td> <td>: 80A</td> </tr> <tr> <td>Rack without internal fan in rack with forced ventilation</td> <td>: 70A</td> </tr> <tr> <td>Rack with internal fan in rack with forced ventilation</td> <td>: 90A/120A</td> </tr> </table> <p>The grayed variants are no longer in production.</p>	Single device without internal fan	: 70A	Single device with internal fan	: 80A	Rack without internal fan in rack with forced ventilation	: 70A	Rack with internal fan in rack with forced ventilation	: 90A/120A
Single device without internal fan	: 70A								
Single device with internal fan	: 80A								
Rack without internal fan in rack with forced ventilation	: 70A								
Rack with internal fan in rack with forced ventilation	: 90A/120A								
Max. peak current	200A (2s)								
Max. input voltage:	55V (in cutoff state/powerless state)								
Galvanic isolated outputs:	100V max. potential difference								
Dimensions single device:	260x68x39mm (including terminals)								
Dimensions single rack:	<table> <tr> <td>Width</td> <td>: 84 HP</td> </tr> <tr> <td>Height</td> <td>: 4 U</td> </tr> <tr> <td>Length</td> <td>: 375 mm</td> </tr> </table>	Width	: 84 HP	Height	: 4 U	Length	: 375 mm		
Width	: 84 HP								
Height	: 4 U								
Length	: 375 mm								
Dimensions dual rack:	<table> <tr> <td>Width</td> <td>: 84 HP</td> </tr> <tr> <td>Height</td> <td>: 7 U</td> </tr> <tr> <td>Length</td> <td>: 375 mm</td> </tr> </table>	Width	: 84 HP	Height	: 7 U	Length	: 375 mm		
Width	: 84 HP								
Height	: 7 U								
Length	: 375 mm								

Shunt Resistance:

Measurement range	Resistance
1mA	100Ω
10mA	10Ω
100mA	1Ω
1A	100mΩ
10A	10mΩ
200A	0.5mΩ

Max. internal resistance	2.3mΩ between terminals in 200A range
Sample frequency:	50kHz / 20μs
Bandwidth:	Up to 1.59kHz (adjustable)
Refresh rate DAC:	20μs per Channel 20μs, if one output channel active 80μs, if all 4 output channels active



Tolerance Channel Common:

Measurement range	tolerance* ¹
1mA	0.4%
10mA	0.4%
100mA	0.4%
1A	0.4%
10A	0.4%
200A	0.5%

Tolerance Channel A, B, C:

Measurement range	tolerance* ¹
1mA	0.4%
10mA	0.4%
100mA	0.4%
1A	0.4%
10A	0.4%
200A	0.5%

*¹ of the respective measurement range max. value

Address:

Preis Ingenieurbüro GmbH
Hauptstraße 4
77830 Bühlertal

Tel: 07223 283131-0
Fax: 07223 283131-7

www.preis-ing.de